

SERIE:80

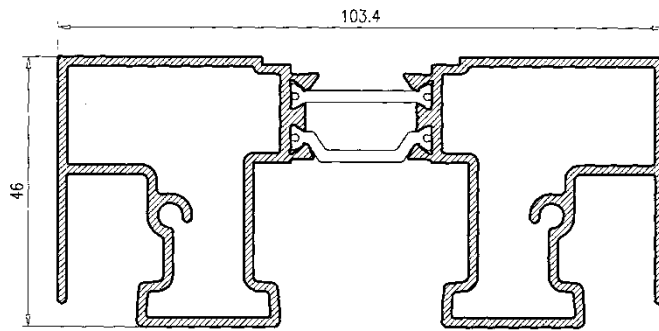

Marco Superior

80

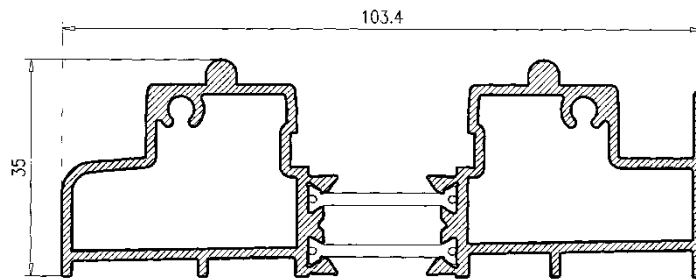

Marco Inferior

81

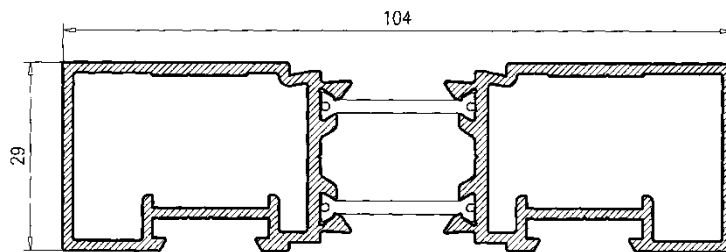

Marco Lateral

82

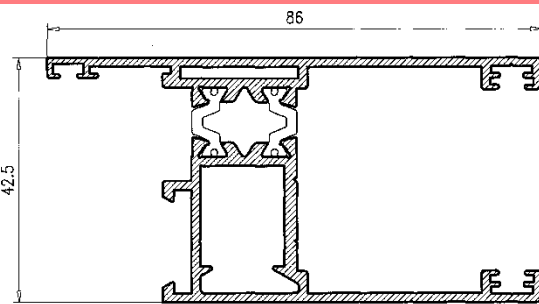

Hoja

83

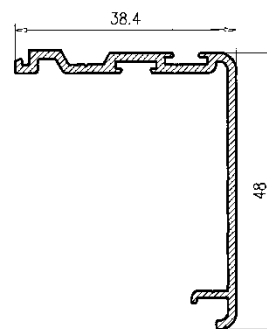

Cruce Central

84

SERIE:80

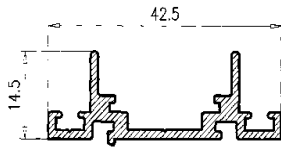

Cierre Marco Lateral
85

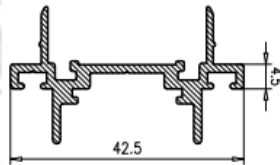

Cierre 4 Hojas
886

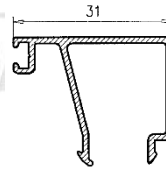

Junq. Base 31
deja hueco 8
122716

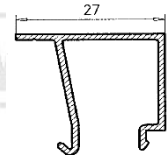

Junq. Base 27
deja hueco 12
122715

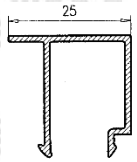

Junq. Base 25
deja hueco 14
122717

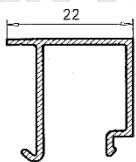

Junq. Base 22
deja hueco 17
122719

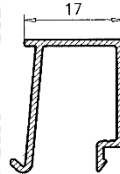

Junq. Base 17
deja hueco 22
122728

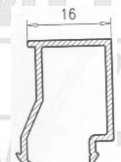

Junq. Base 16
deja hueco 23
122729

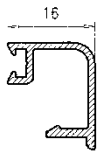

Junq. Grapa 16
deja hueco 23
122724

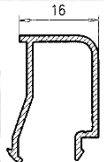

Junq. Clip 16
deja hueco 23
122624

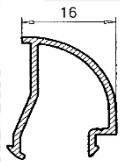

Junq. Clip 16
deja hueco 23
122627

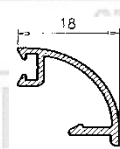

Junq. Grapa 16
deja hueco 23
122727



Junq. Base 14
deja hueco 25
122730

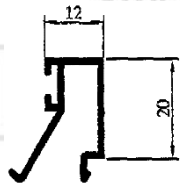

Junq. Base 12 deja
hueco 27
122712

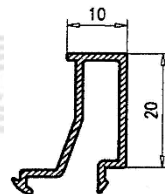

Junq. Base 10 deja
hueco 29
122710

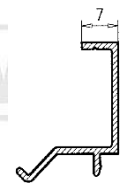

Junq. Base 7 deja
hueco 32
122725