

SERIE-CELOSIA

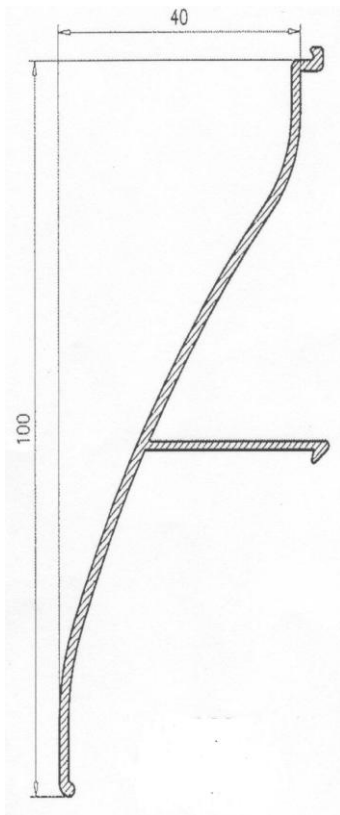

Lama de 100

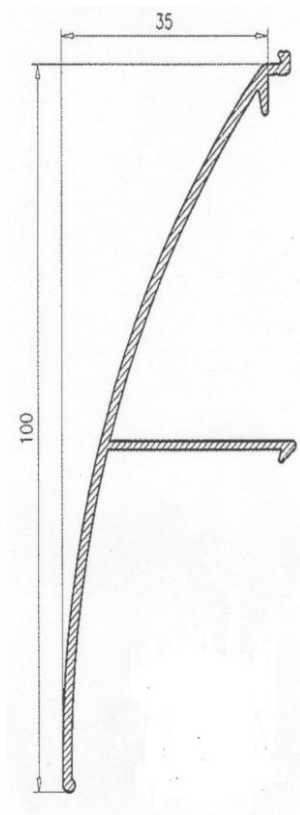

Lama de 100

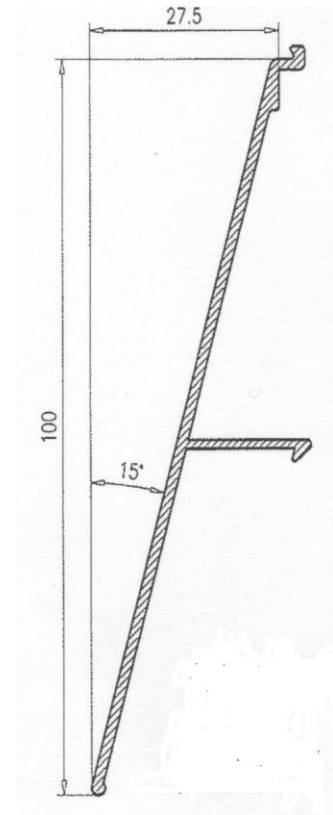

Lama de 100

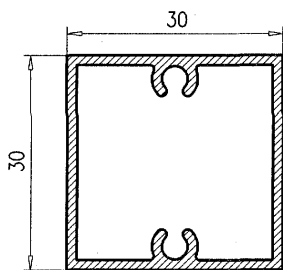

Cuadrado de 30 autorroscado 100

Esquema del montaje de la LAMA.

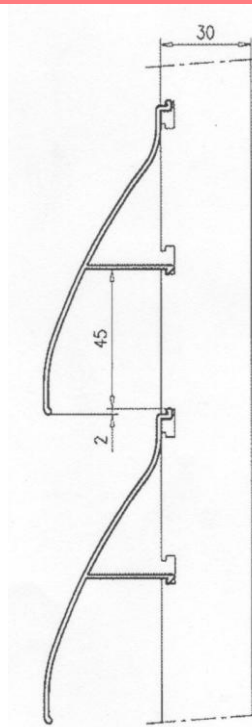
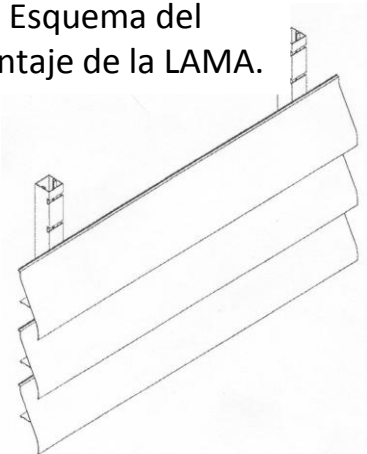

Montante paso LARGO
10 LAMAS / METRO

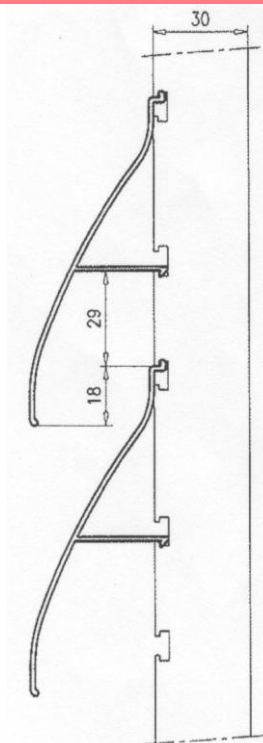

Montante paso CORTO 12
LAMAS / METRO

SERIE-CELOSIA

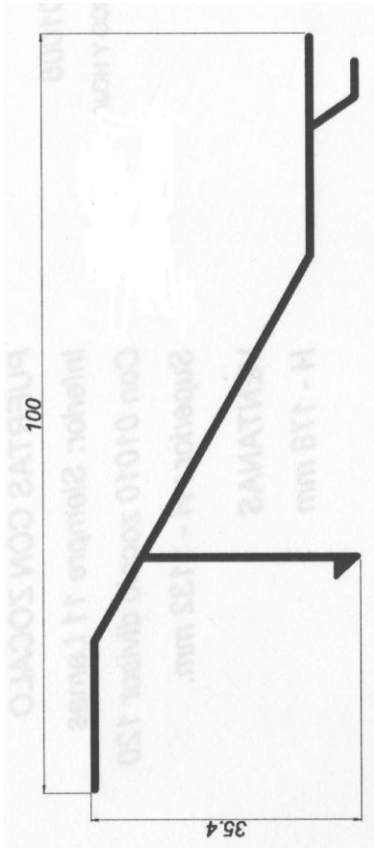

Lama de 100 **33**

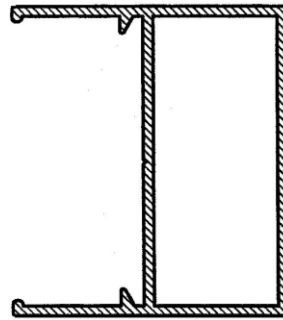

Montante 100
troquelado paso 0
24T

Esquema de montaje
de la LAMA

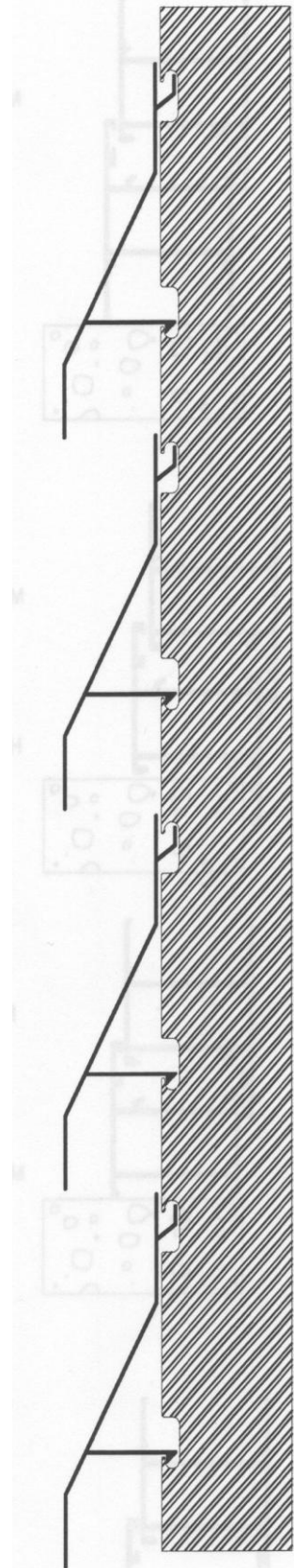
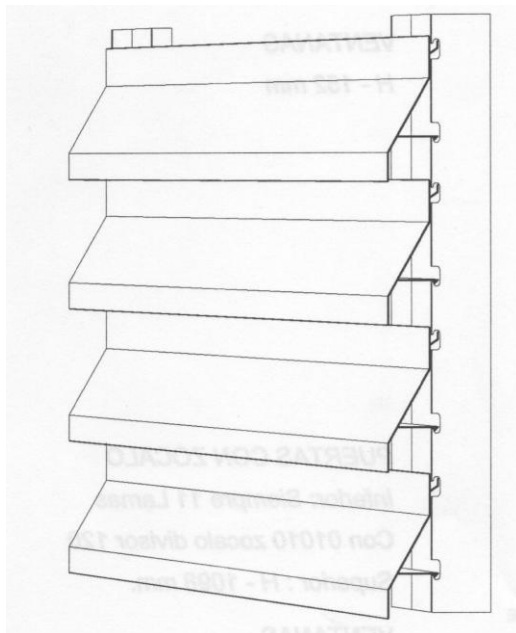

SERIE-CELOSIA

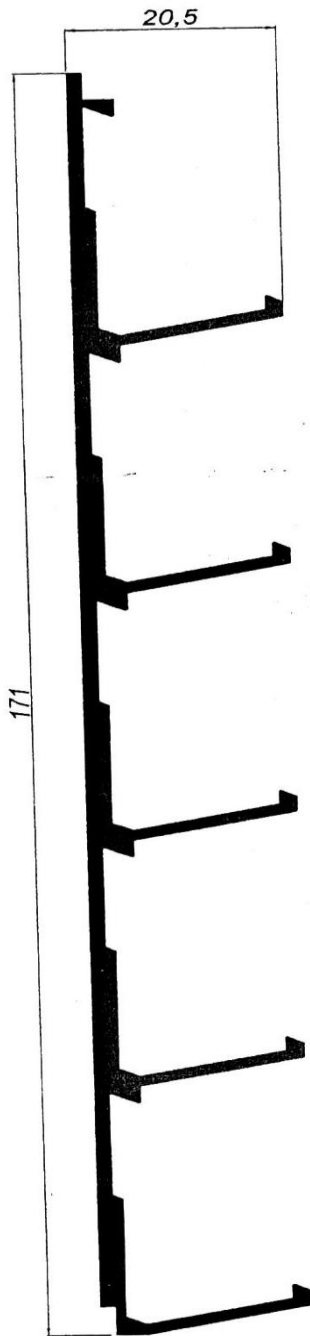

Soporte Lama Peine
171
915

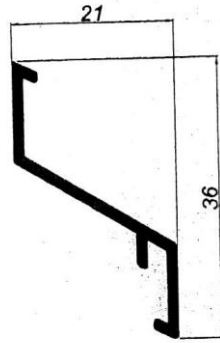

Lama de 36 916

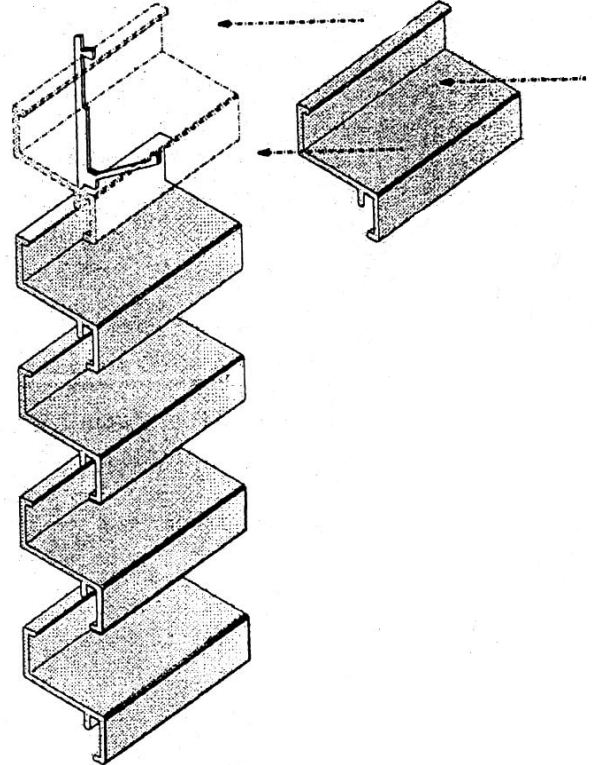

Esquema de montaje de la LAMA y el SOPORTE

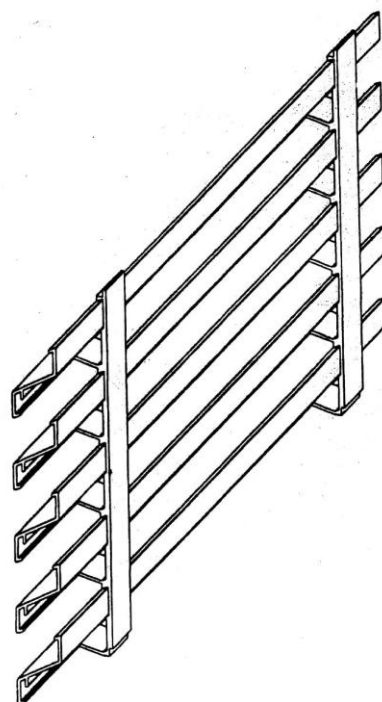

SERIE-CELOSIA

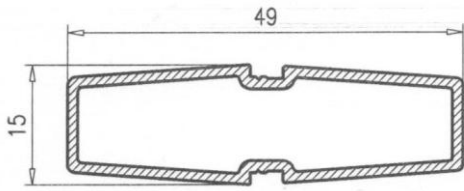

Lama Celosía 49*15
919

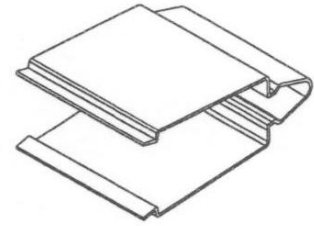

Grapa Celosía Fija

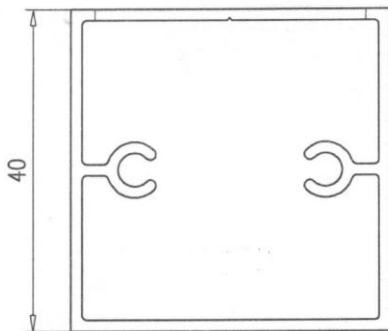

Cuadrado 40
autorroscado
101

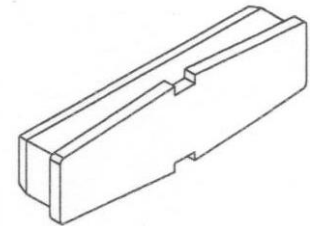

Tapa Lama Celosía

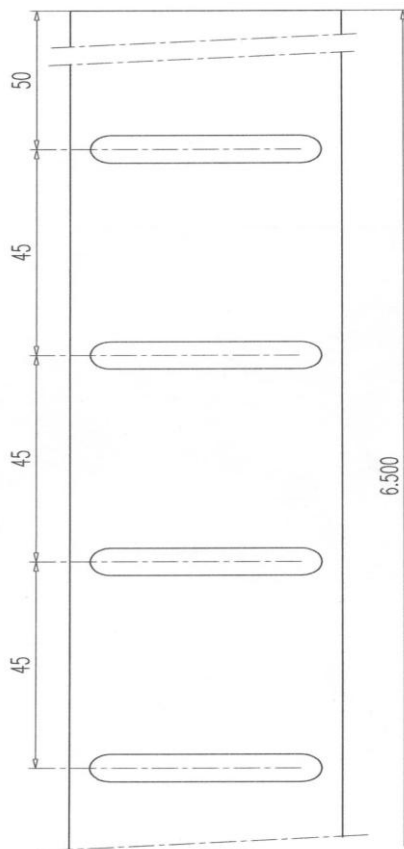

Montante paso 45 mm
22 LAMAS / METRO

Esquema de montaje de la LAMA y el SOPORTE

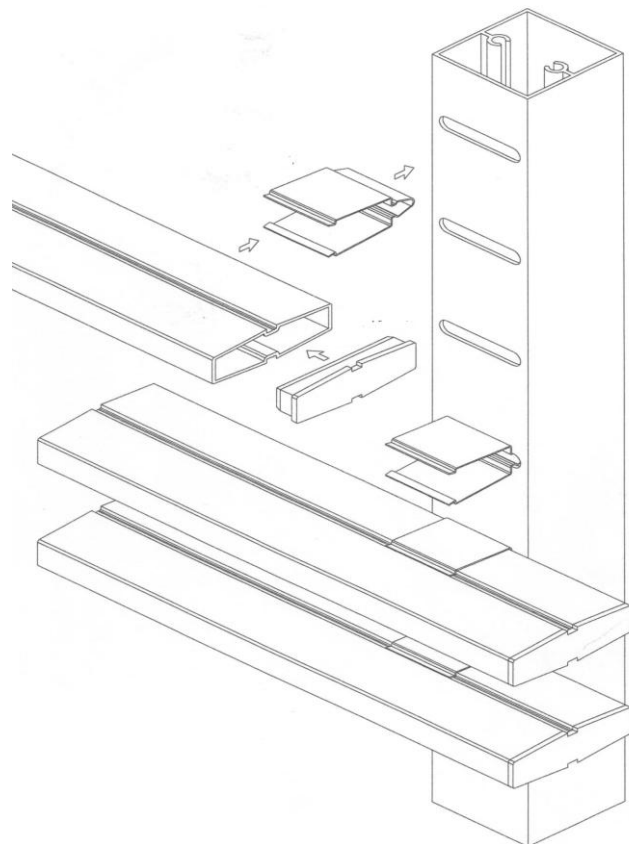

SERIE-CELOSIA

94

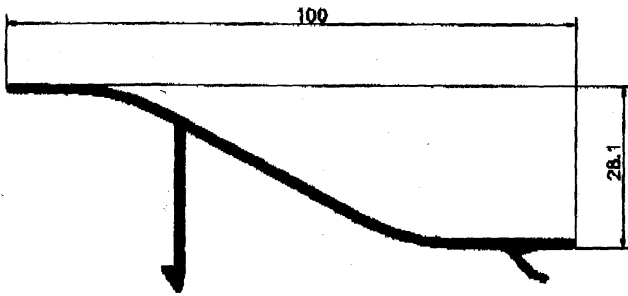

Lama Celosia de 100 Canto Curvo **31**

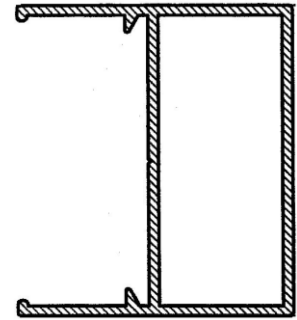

Montante 100 Paso 0 **24T**

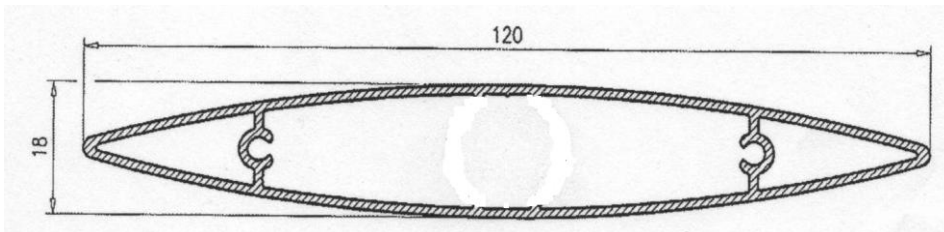

Lama ala Avión 120
2858

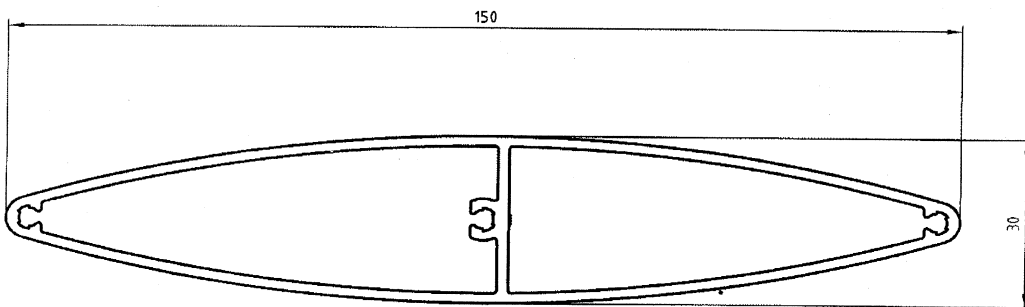

Lama ala Avión 150
2856

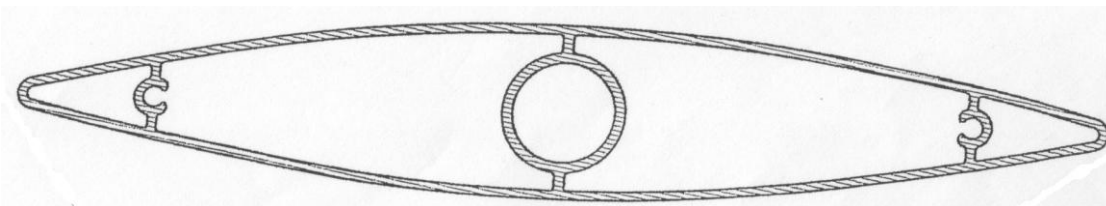

Lama ala Avión
160
2857

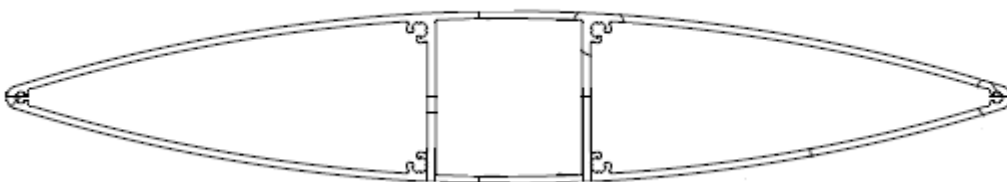

Lama Avion
350 con
tabique
2859

NOTA: DISPONEMOS DE DIFERENTES FORMAS Y TAMAÑOS DE LAMA AVION. CONSULTAR