

**SERIE:GUIA PERSIANA Y COMPACTOS**

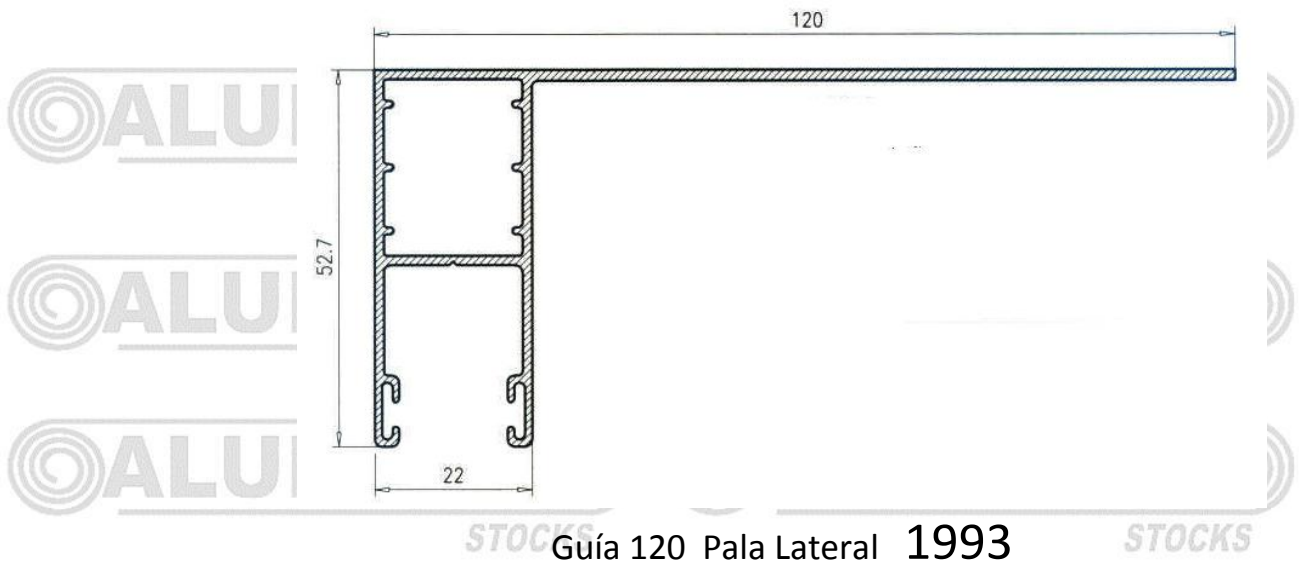

Guía 120 Pala Lateral 1993

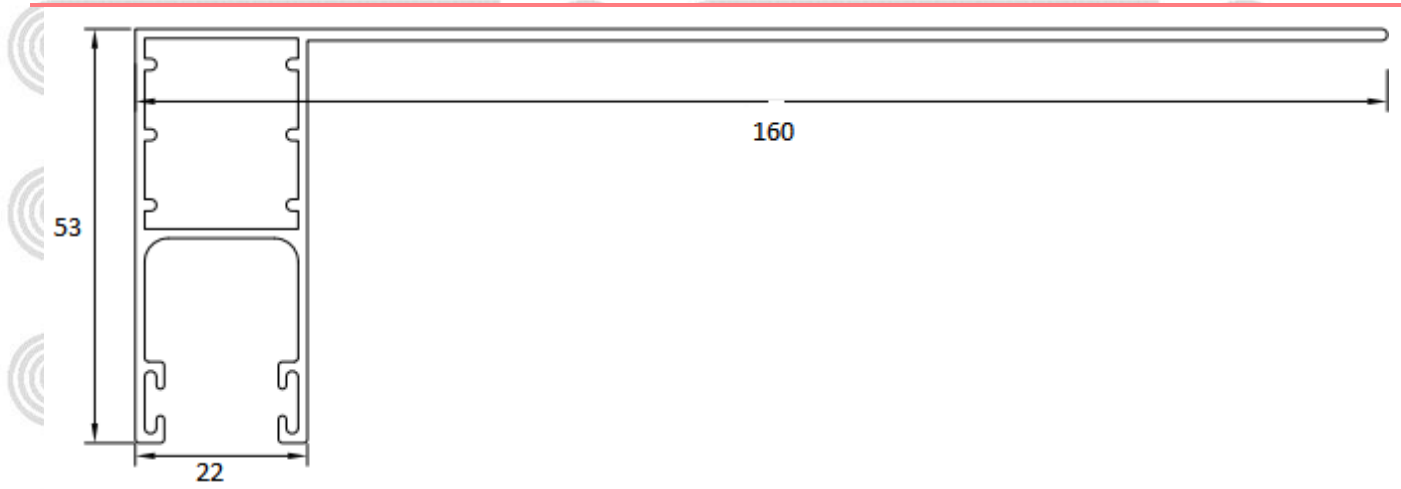

Guía 160 Pala Lateral 3259

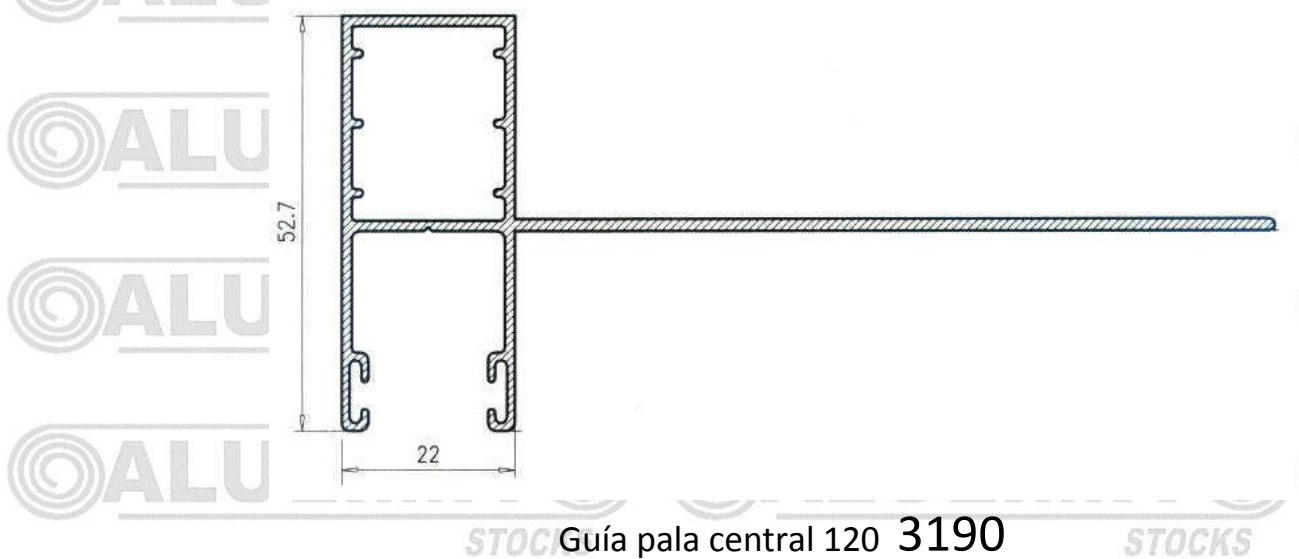

Guía pala central 120 3190

**SERIE:GUIA PERSIANA Y COMPACTOS**

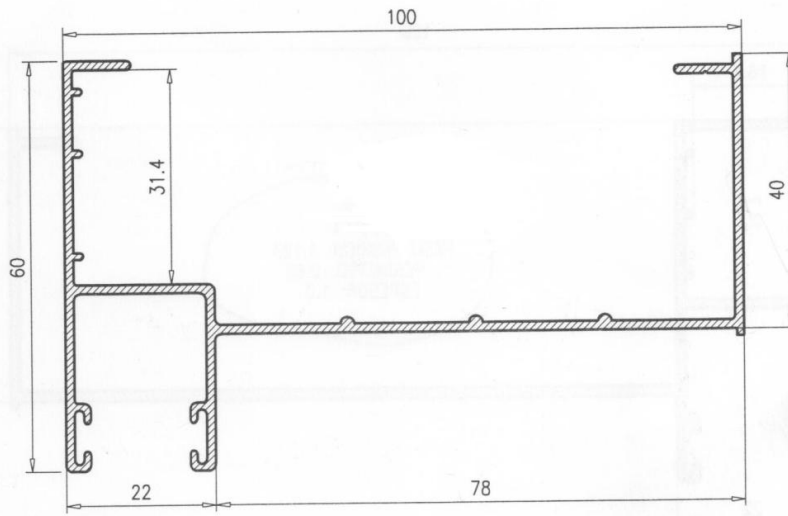

Guía 100 con solape. Guía Madrid 5476

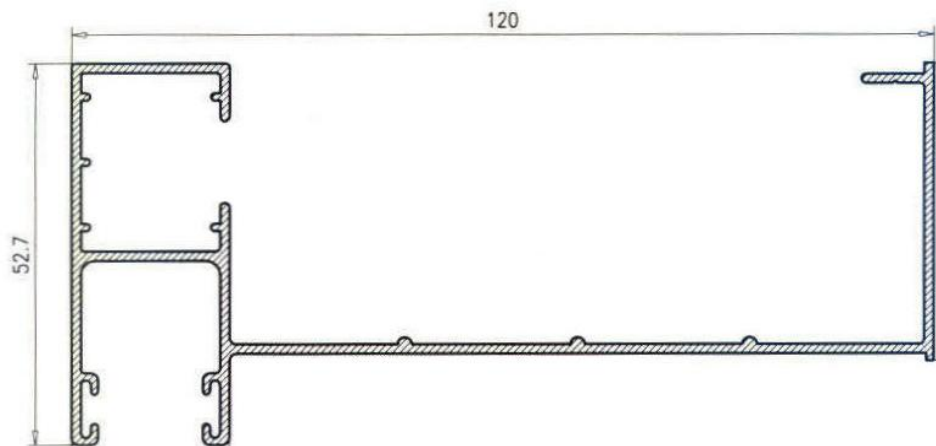

Guía 120 abierta con solape. Guía Madrid 5470



Guía 140 Madrid 5477

**SERIE:GUIA PERSIANA Y COMPACTOS**

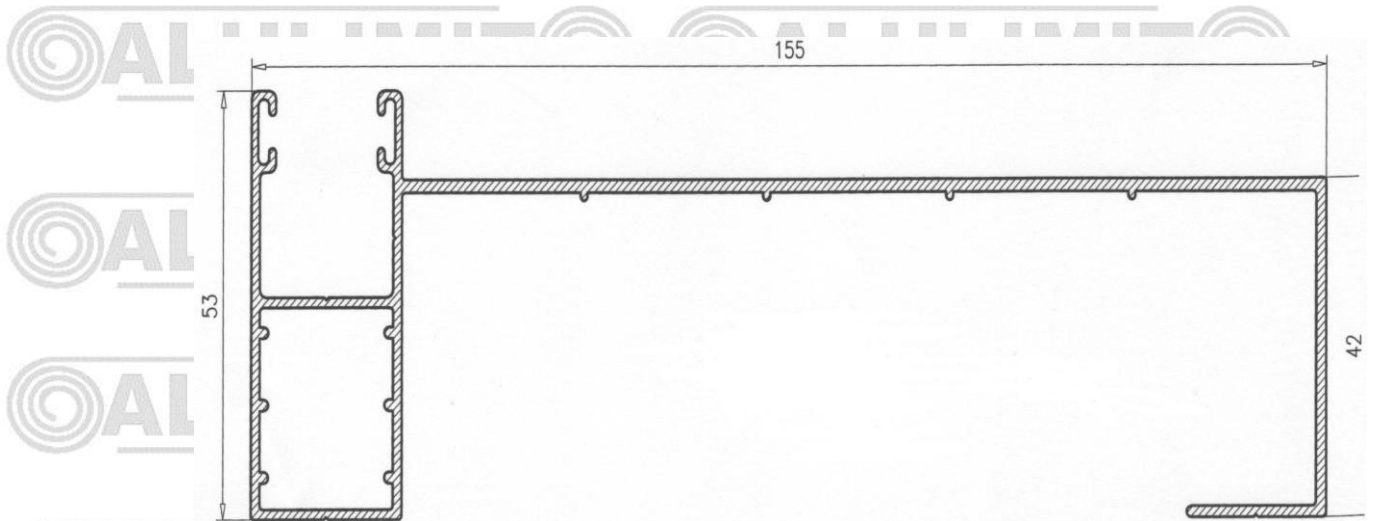

Guía 155 con solape Guía Madrid 5475

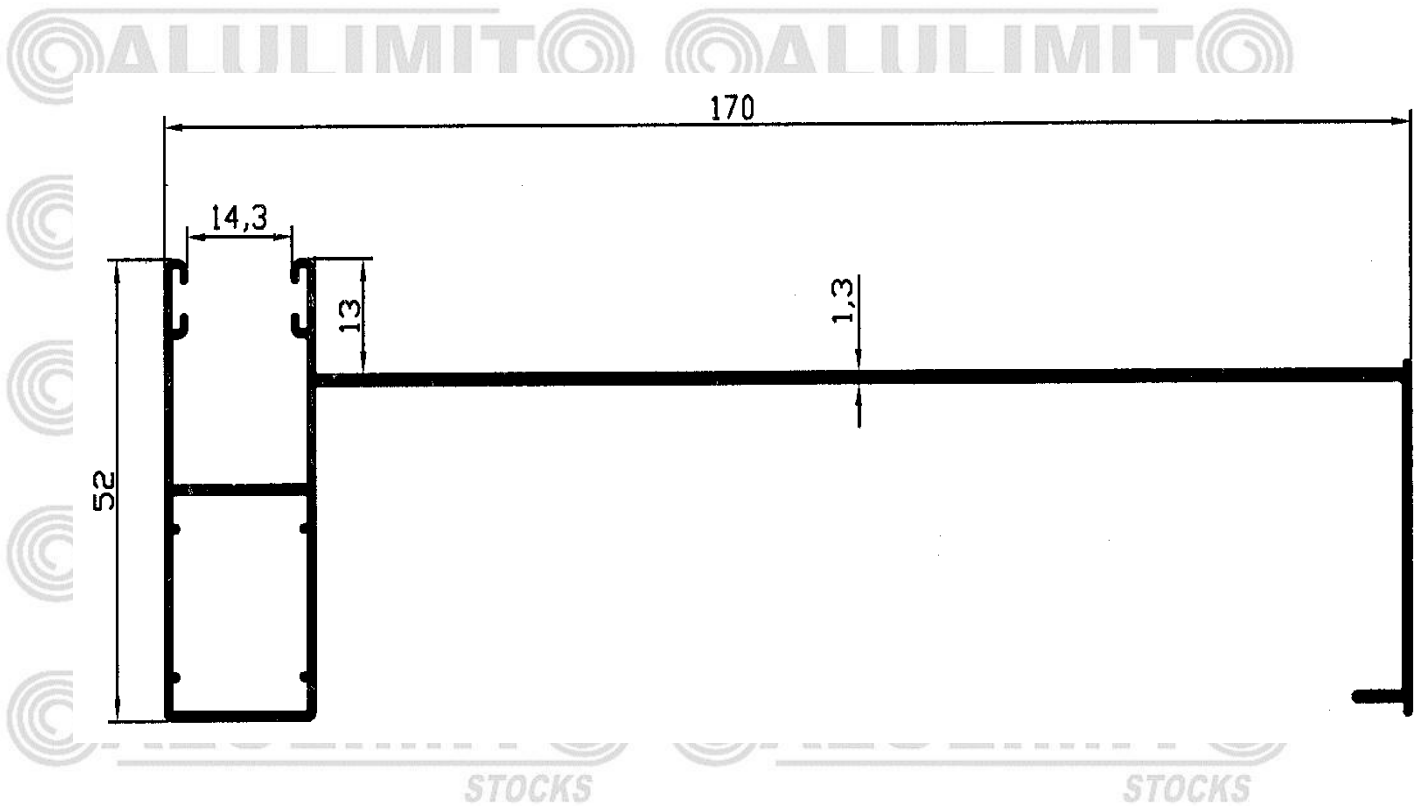

Guía 170 con solape Guía Madrid 8150

## SERIE:GUIA PERSIANA Y COMPACTOS

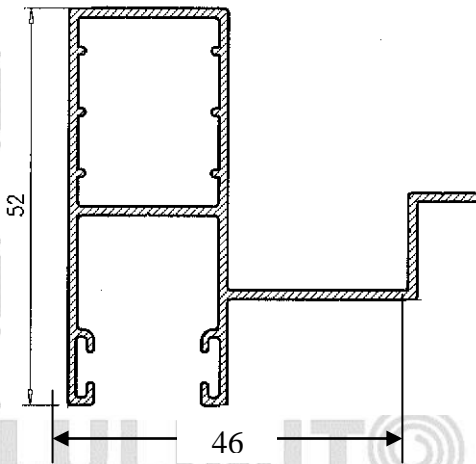

Guía Pala Int. 46 recogedor embutido. **8143**

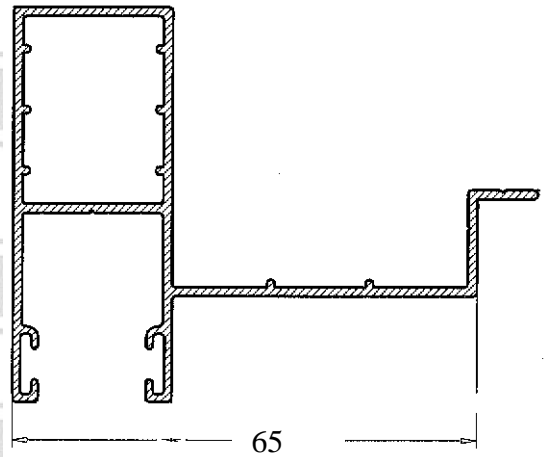

Guía Pala Int 61.2 recoge. emb. **8145**

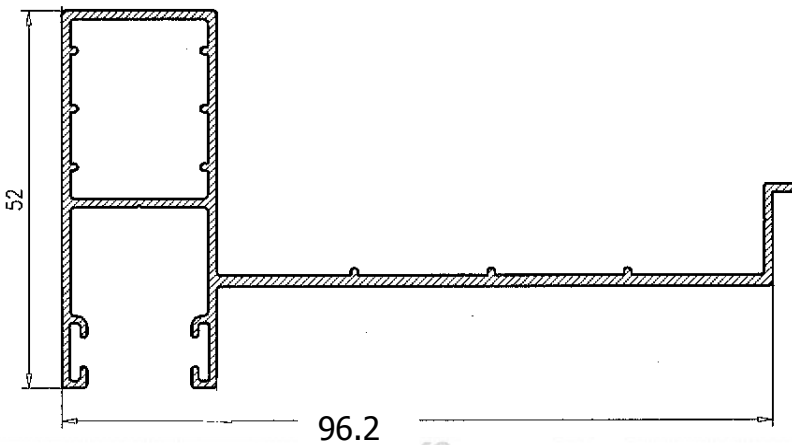

Guía Pala Interior 96.2 de recogedor embutido **8149**

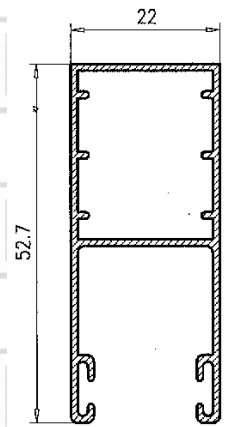

Guía Mini **3522**

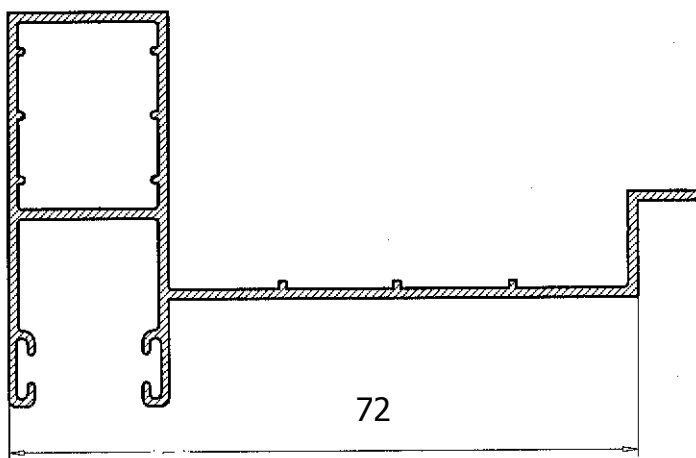

Guía Pala Int 72 recog. embutido **8146**

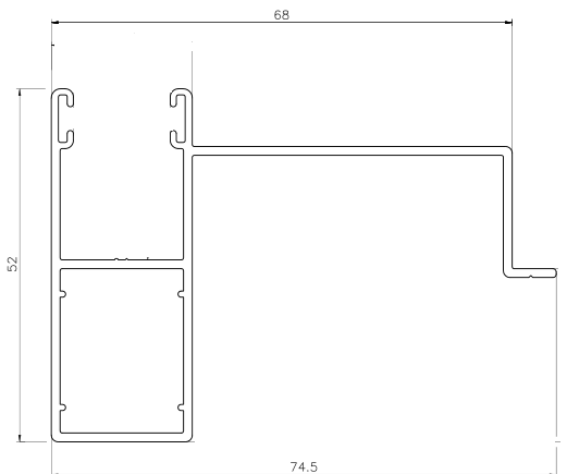

Guía para premarco RT 68 **5299**

**SERIE:GUIA PERSIANA Y COMPACTOS**

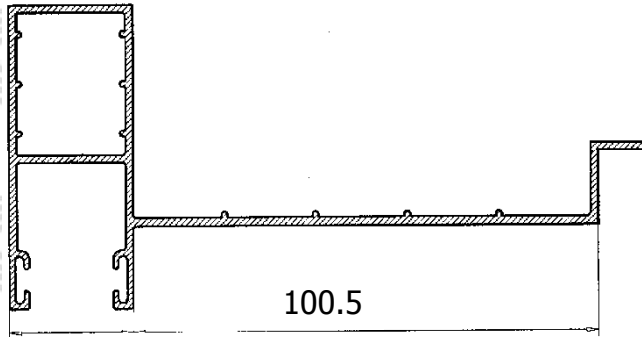

Guía Pala Int 100.5 recog. embutido **4437**

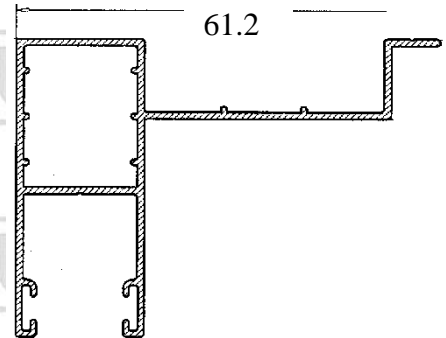

Guía Pala Ext 61.2 recog.solapado **8144**

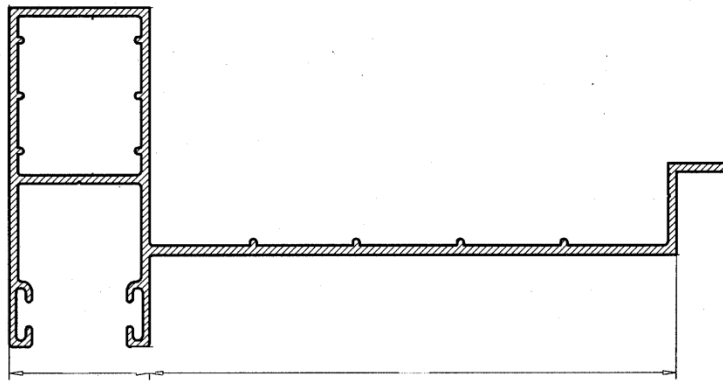

Guía Pala Interior 115 de recogedor embutido **4438**

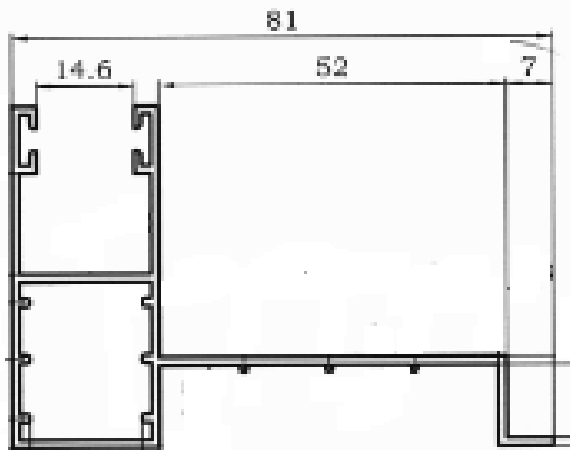

Guía Pala Exterior 74 recogedor solapado **8151**

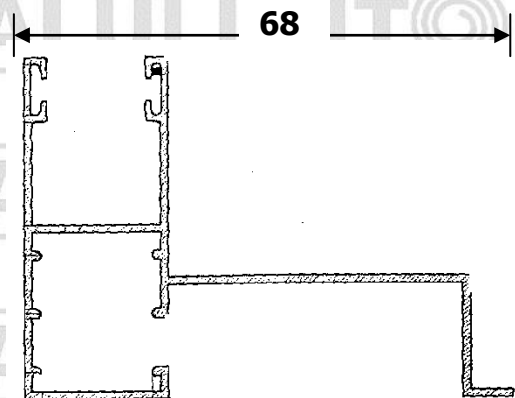

Guía Pala Exterior 68 de recogedor solapado **8142**

**SERIE:GUIA PERSIANA Y COMPACTOS**

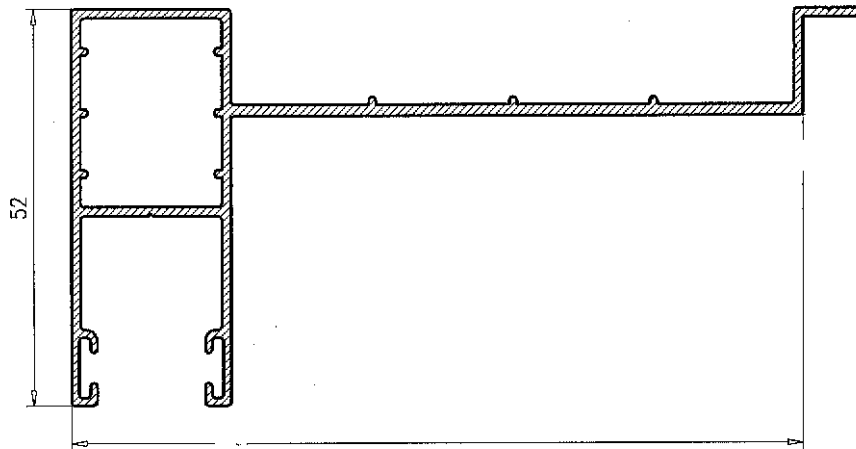

Guía Pala Exterior 96.2 de recogedor solapado **8148**

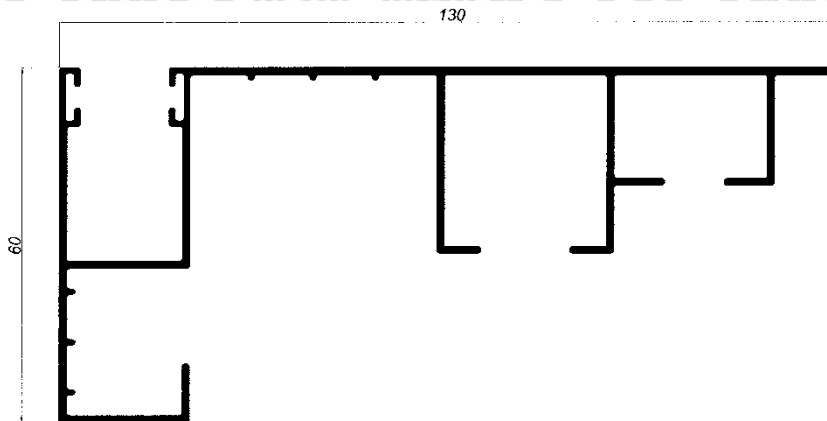

Guía Recogedor de 130 con premarco de obra **8185**

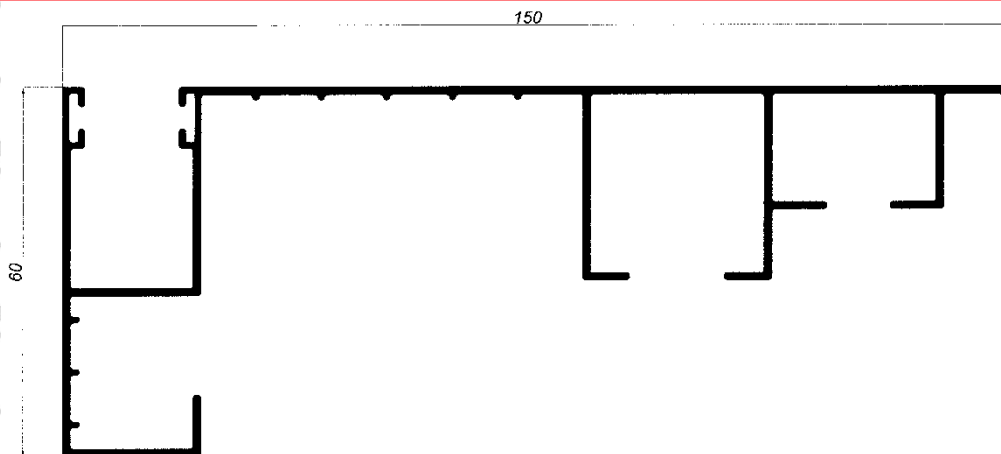

Guía Recogedor de 150 con premarco de obra **8260**

**SERIE:GUIA PERSIANA Y COMPACTOS**

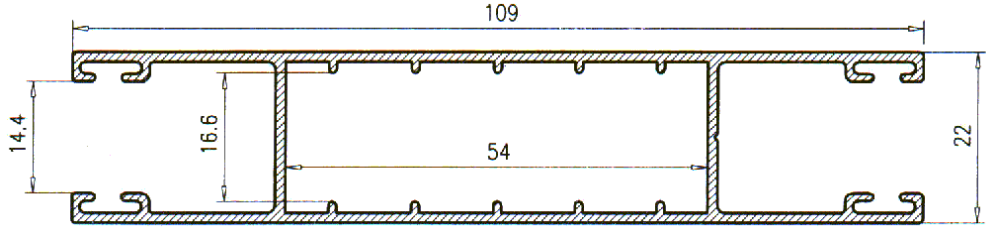

Guía Doble Persiana 3521

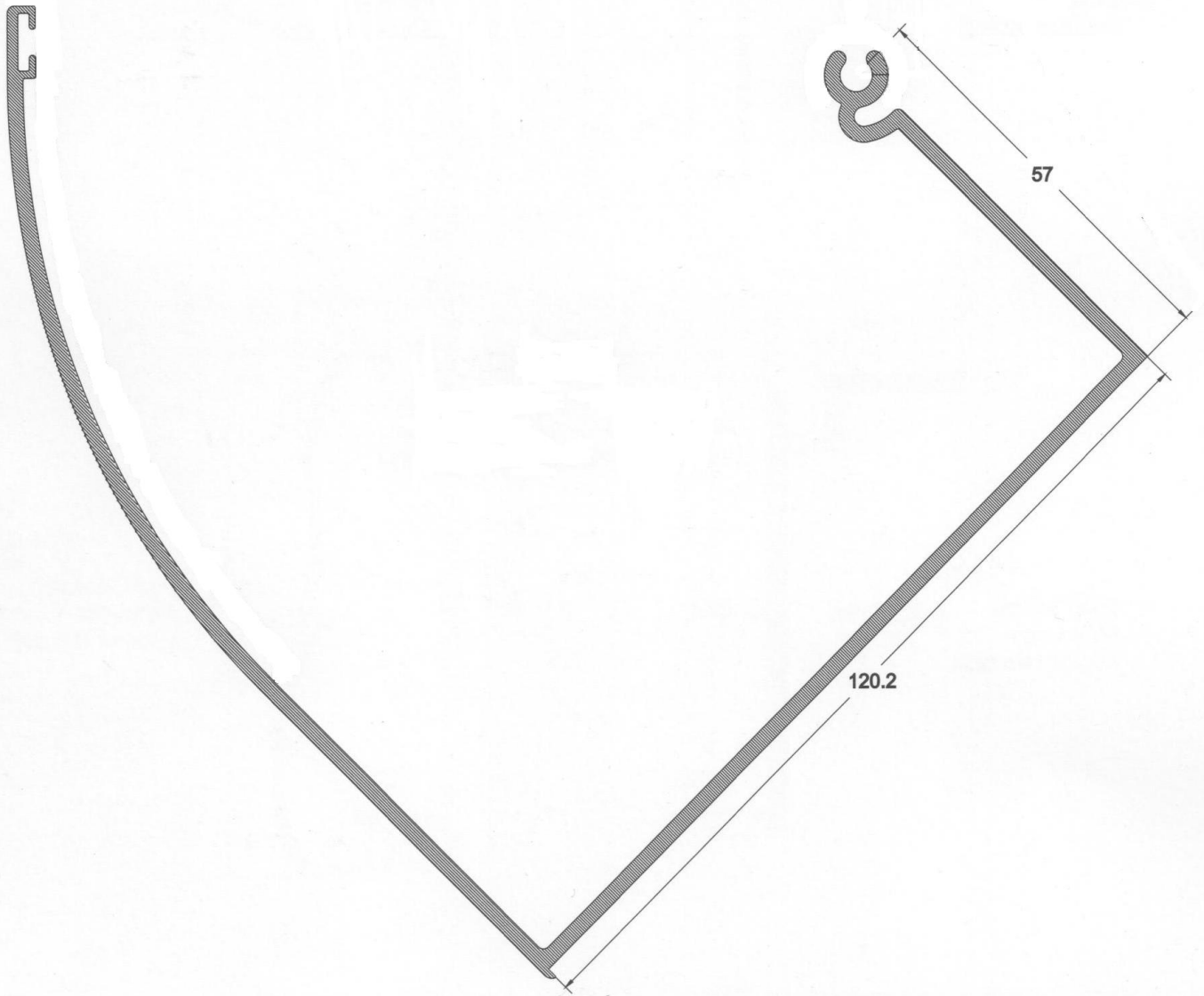

Esquinero Regulable Macho 11011

**SERIE: GUIA PERSIANA Y COMPACTOS**

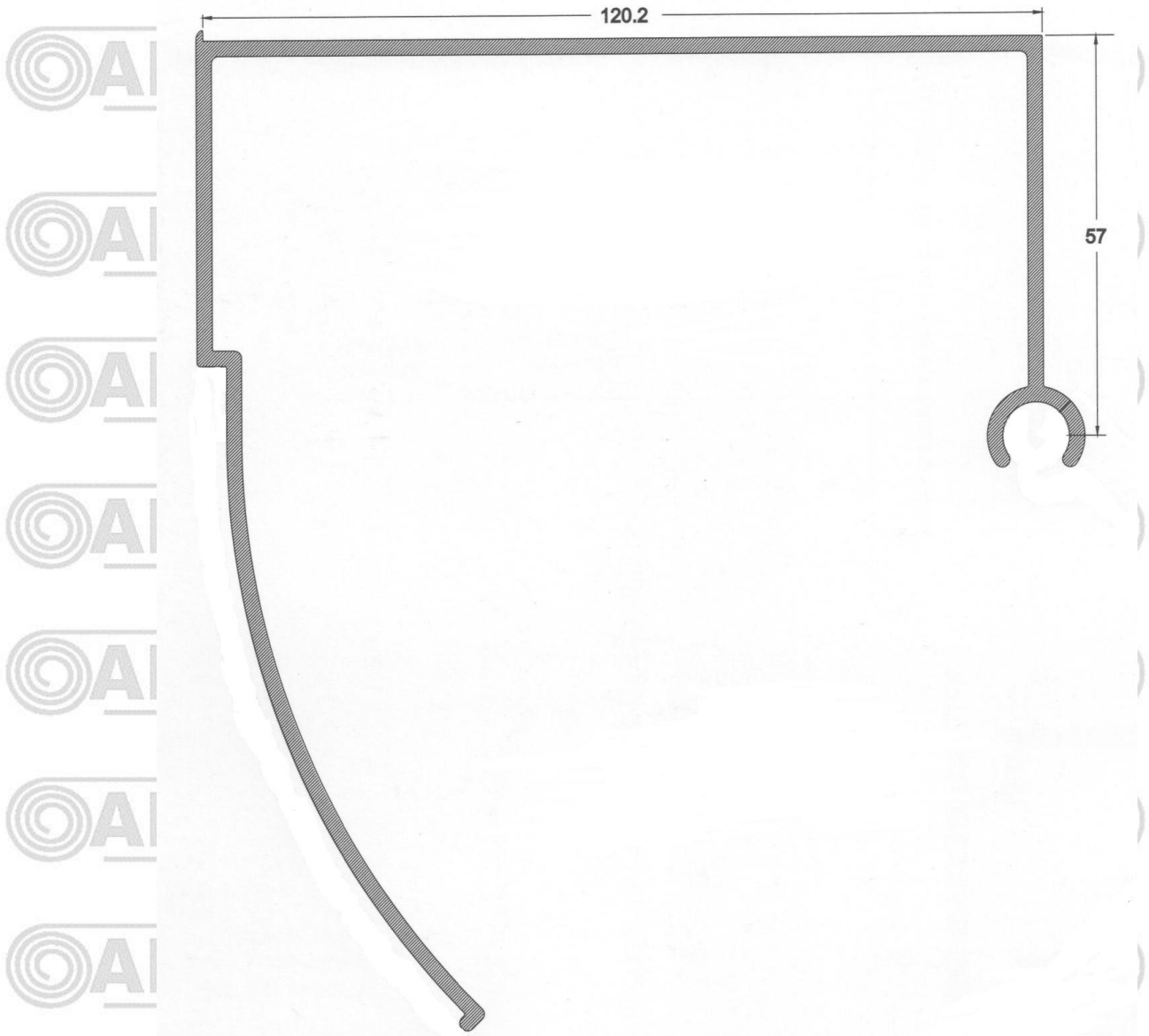

Esquinero Regulable Hembra 11012

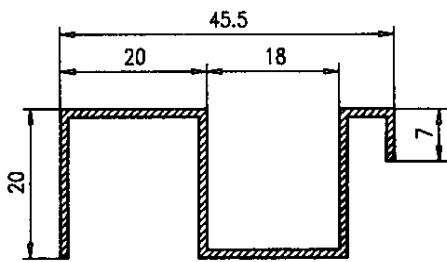

Guía 46 G46

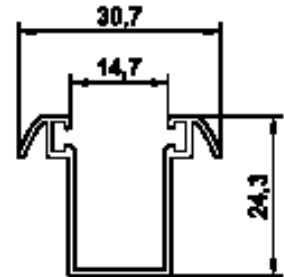

Guía Embutir V-25 920



**SERIE:GUIA PERSIANA Y COMPACTOS**

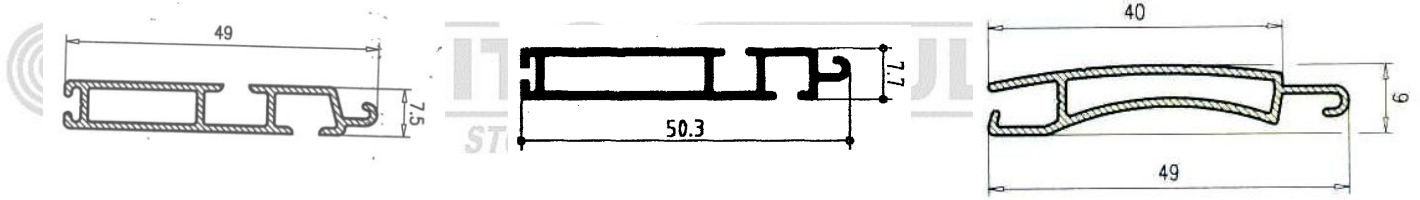

Terminal Persiana 40  
4384

Terminal Persiana 50  
4385

Lama Persiana 40  
7932

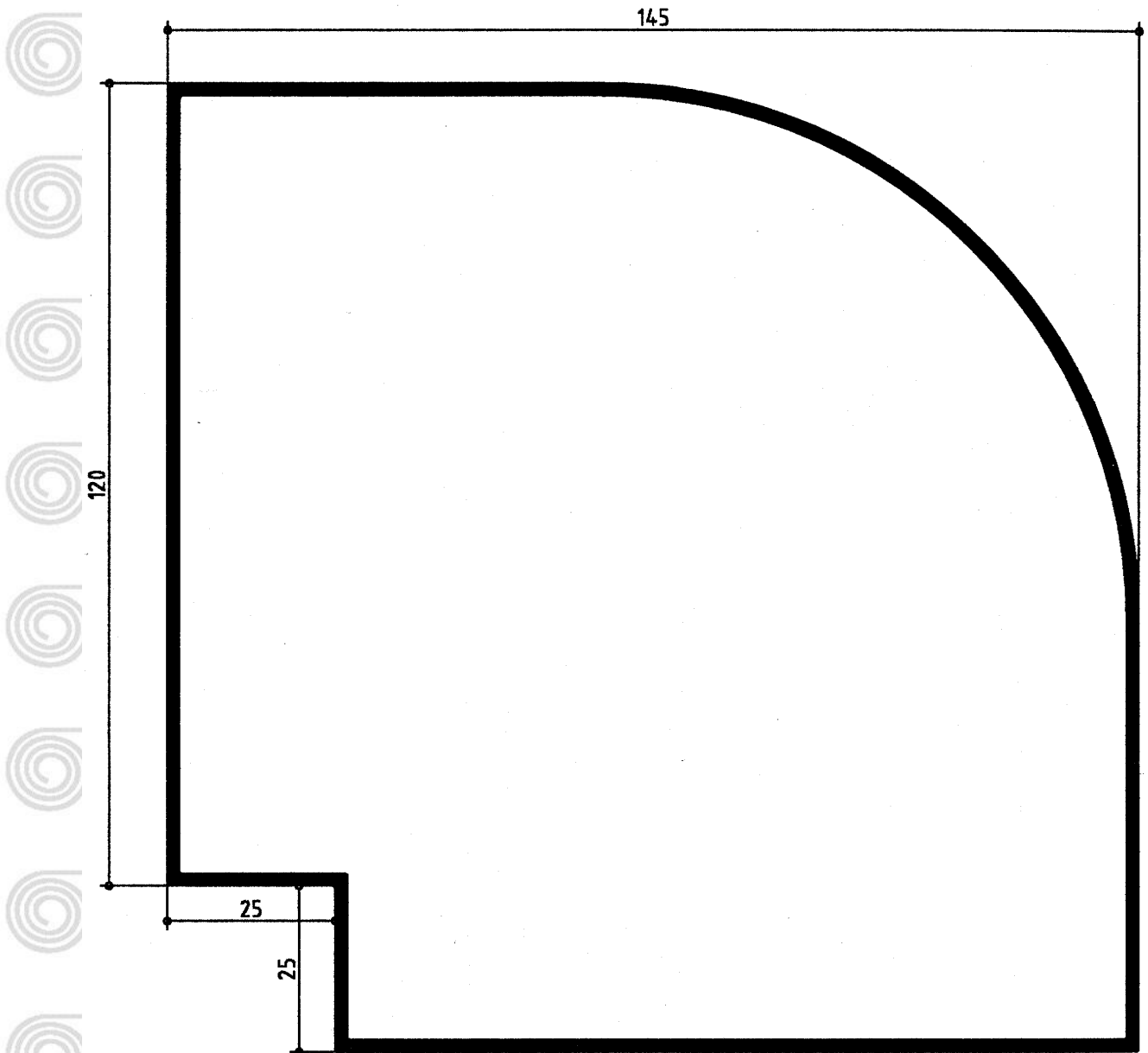

Esquinero Compacto 145 11013